

33X

ClampMeters

*Calibration Information***Introduction****⚠ Warning**

To avoid electric shock or injury, do not perform the performance tests or calibration procedures unless you are qualified to do so.

The information provided in this manual is for the use of qualified personnel only.

The *33X Calibration Information* provides the information necessary to verify the performance and adjust the calibration of the Fluke 333, 334, 335, 336, and 337 ClampMeters, hereafter known as the Meter(s).

The following information is included in this document:

- Safety Information and International Electrical Symbols
- Specifications
- Replacing the Batteries
- Cleaning
- Performance Tests
- Calibration Adjustment
- User-Replaceable Parts and Accessories
- Warranty Statement

See the *33x Instruction Cards* for complete operating instructions.

Contact Information

To contact Fluke, call:

1-888-99-FLUKE (1-888-993-5853) in USA
1-800-36-FLUKE (1-800-363-5853) in Canada
+31 402-678-200 in Europe
+81-3-3434-0181 Japan
+65-276-6196 Singapore
+1-425-446-5500 in other countries

For additional information about Fluke, its products, and services, visit Fluke's web site at:

www.fluke.com

To register this product, go to register.fluke.com

Safety Information













Warnings and Precautions

To avoid possible electric shock or personal injury, and to avoid possible damage to the Meter or the equipment under test, adhere to the following practices:

- Avoid working alone so assistance can be rendered.
- Never use the Meter on a circuit with voltages higher than 600 V or a frequency higher than 400 Hz fundamental. The meter may be damaged.
- Do not use the Meter or test leads if they look damaged.
- Use extreme caution when working around bare conductors or bus bars. Contact with the conductor could result in electric shock.
- Read the instruction card and safety sheet before use and follow all safety instructions.
- Use the Meter only as specified in the instruction card; otherwise, the Meter's safety features may be impaired.
- Use caution when working with voltages above 60 V dc or 30 V ac. Such voltages pose a shock hazard.
- Before using the Meter, inspect the case. Do not use the Meter if it is damaged. Look for cracks or missing plastic. Pay particular attention to the insulation around the connectors.
- Verify the Meter's operation by measuring a known voltage. Do not use the Meter if it operates abnormally. Protection may be impaired. When in doubt, have the Meter serviced.
- Do not apply more than the rated current or voltage, as marked on the Meter.
- Use the proper terminals, function, and range for your measurements.
- Do not operate the Meter with the case (or part of the case) removed.
- When servicing the Meter, use only specified replacement parts.

International Electrical Symbols

The following international symbols appear in this document and on the Meter.

	Risk of electric shock
	Risk of danger. Important Information. See manual.
	Equipment protected by double or reinforced Insulation
	Battery
	Conforms to CSA C22.2 No 1010. 2.032-96
	Conforms to EU directives
	Earth
	DC measurement
	AC measurement
 N10140	Conforms to relevant Australian standards
	Conforms to UL 3111-1 and UL 3111-2-032
	Inspected and licensed by TÜV Product Services

Specifications

*These specifications apply @ 23 °C ± 5 °C, in relative humidity of 0 - 90%		333	334	335	336	337
\tilde{A} (50 Hz/60 Hz)	Range	0 - 400.00 A	0 - 600.0 A			0 - 999.9 A
	Accuracy	2 % ± 5 counts (50/60 Hz)			2 % ± 5 counts (10 - 100 Hz) 6 % ± 5 counts (10 - 400 Hz)	
	Crest Factor add 2% for CF > 2	NA	NA	2.4 @ 500 A 2.0 @ 600 A	3 @ 500 A 2.5 @ 600 A	3 @ 500 A 2.5 @ 600 A 1.42 @ 1000 A
	AC response	Avg		Rms		
Inrush Current	Integration Time	NA	100 ms			
\bar{A}	Range	NA	NA	NA	0 - 600.0 A	0 - 999.9 A
	Accuracy	NA	NA	NA	2 % ± 5 counts	
\tilde{V}	Range	0 - 600.00 V				
	Accuracy	1 % ± 5 counts 50/60 Hz			1 % ± 5 counts (20 - 100 Hz) 6 % ± 5 counts (100 - 400 Hz)	
\bar{V}	Range	0 - 600.0 V				
	Accuracy	1 % ± 5 counts				
Ω	Range	0 - 600.0 Ω	0 - 600.0 Ω 600 - 6000 Ω			
	Accuracy	1 % ± 5 counts				
Continuity	\llcorner)	≤ 30 Ω				
Hz-Amps Only Trigger Level: 10-100 Hz ≥ 5 A 5-10 Hz, 100-400 Hz > 10 A	Range	NA	NA	NA	NA	5.0 - 400.0 Hz
	Accuracy	NA	NA	NA	NA	0.5 % ± 5 counts
Storage Temperature		-40 °C to 60 °C				
Operating Temperature		-10 °C to 50 °C				
Altitude		2500 m				
EMC- instrument unspecified for use in EMC field ≥ 0.5 V/m						
CAT III 600 V, Pollution Degree II: CAT III equipment is designed to protect against transients in equipment in fixed-equipment installations, such as distribution panels, feeders and short branch circuits, and lighting systems in large buildings.						
* < 18 °C, > 28 °C add 0.1 x (specified accuracy)/°C						

Replacing the Batteries

⚠ Warning

To avoid false readings, that could lead to possible electric shock or personal injury, replace the batteries as soon as the low battery indicator () appears.

Disconnect the test leads before replacing the batteries.

To replace the batteries (refer to Figure 1):

1. Turn the rotary switch to **OFF** and remove the test leads from the terminals.
2. Loosen the battery compartment door screw, and remove the door from the case bottom.
3. Remove the batteries.
4. Replace the batteries with 2 new AA batteries.
5. Reattach the battery compartment door to the case bottom and tighten the screw.

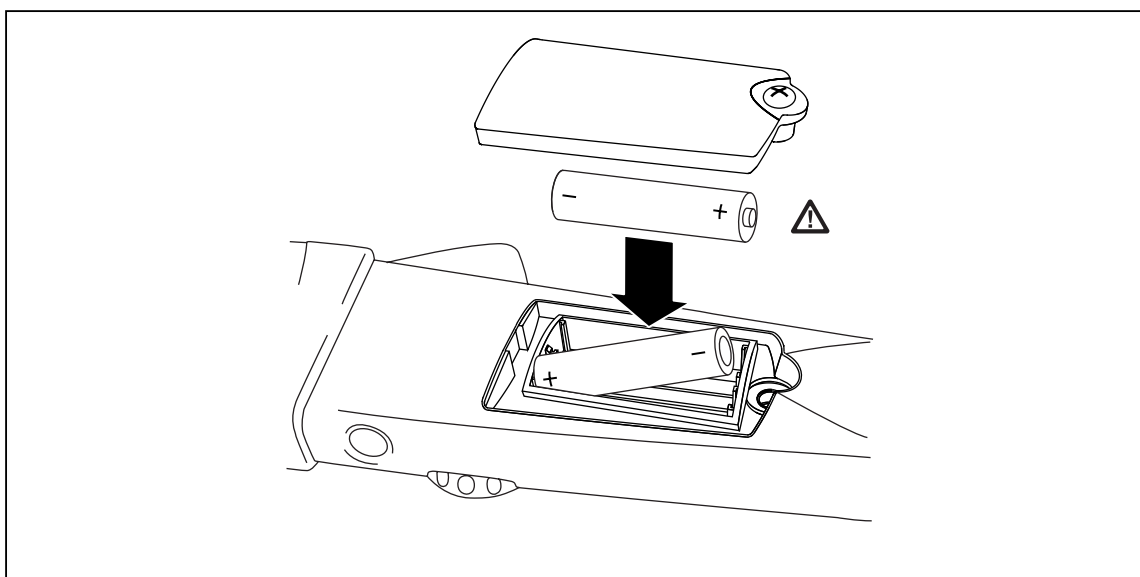

Figure 1. Replacing the Batteries

adc02f.eps

Cleaning

⚠ Warning

To avoid electrical shock, remove any input signals before cleaning.

Caution

To avoid damaging the Meter, do not use aromatic hydrocarbons or chlorinated solvents for cleaning. These solutions will react with the plastics used in the instruments.

Clean the instrument case with a damp cloth and mild detergent.

Performance Tests

⚠ Warning

To avoid electric shock, do not perform the performance test procedures unless the Meter is fully assembled.

The following performance tests verify the complete operation of the Meter and check the accuracy of each meter function against the Meter's specifications. If the Meter fails any part of the test, calibration adjustment and/or repair is indicated.

In the performance tests, the Meter is referred to as the unit under test (UUT).

Table 1. Required Equipment

Equipment	Recommended Model
AC Calibrator	Fluke 5520A
Digital Multimeter (DMM)	Any Fluke model
50-Turn Current Coil	Fluke 5500A/Coil

Testing the Display

For models 334 - 337, test the display by turning the Meter on while holding down the INRUSH button. Check all segments for clarity and contrast. The 333 is not equipped with this feature. Refer to Figure 2.

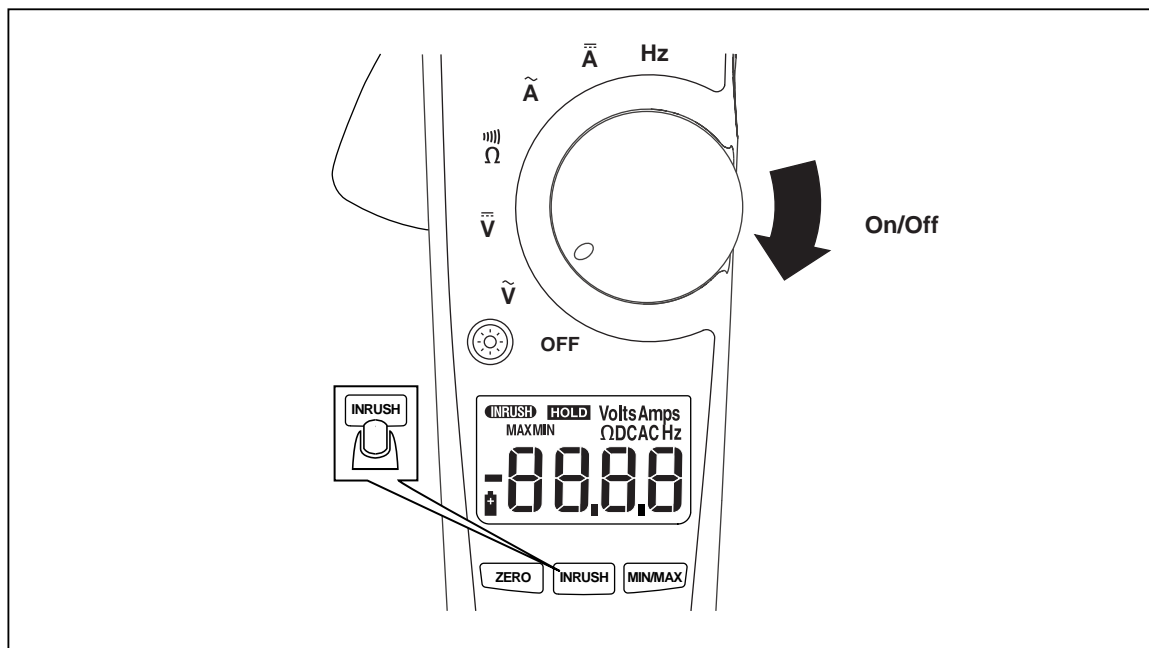



Figure 2. Testing the Display (337 is shown)

adc01f.eps

Backlight Test

The 334, 335, 336, and 337 Clampmeters are equipped with a display backlight. To test the backlight, press . The backlight will come on and the unit will beep. To turn off the backlight, press  a second time. Refer to Figure 3.

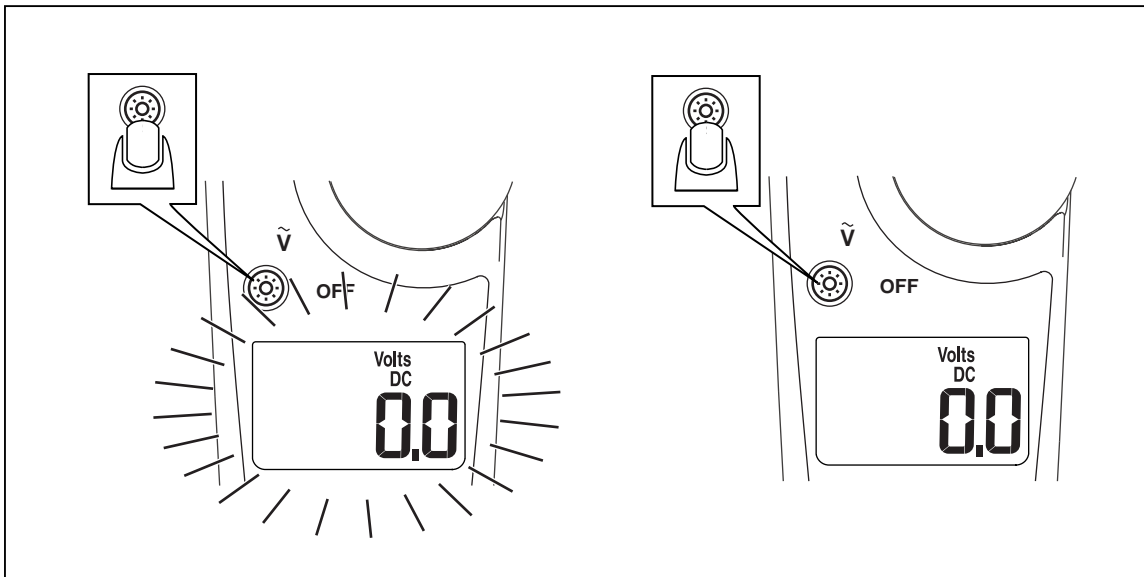

Figure 3. Testing the Backlight

adc03f.eps

Keypad Test

To test the keypad, turn the Meter on and push each button separately. Each button push will cause the Meter to beep.

Preparing for the Performance Test

Warning

To avoid possible electric shock or personal injury:

- Do not perform the following procedures unless qualified to do so. Some procedures involve the use of high voltages.
- Before handling the test connections and in between tests, make sure the calibrator is in standby mode (STBY).

To prepare for the performance test:

1. Make sure that you have the required equipment, see Table 1.
2. Warm up the calibrator as required by its specifications.
3. Allow the temperature of the UUT to stabilize at room temperature ($23\text{ }^{\circ}\text{C} \pm 5\text{ }^{\circ}\text{C}$ [$73\text{ }^{\circ}\text{F} \pm 9\text{ }^{\circ}\text{F}$]).

Performance Test Procedure

To test each of the Meter's functions and operating ranges, do the following:

1. Connect the source to the Meter's $V\Omega$ and COM input jacks.
2. Referring to Table 2, put the Meter in the desired function and range for each test.
3. Apply the indicated output from the source.
4. When using the amp function on the 5520A, make sure LCOMP on the 5520A is ON.
5. The reading on the Meter display should be within the low and high limits shown in the table.
6. Repeat steps 1-4 for each function and range in Table 2.

If the Meter fails to perform within the low-high range indicated for each test in Table 2, the Meter needs to be calibrated and adjusted, or requires some repair.

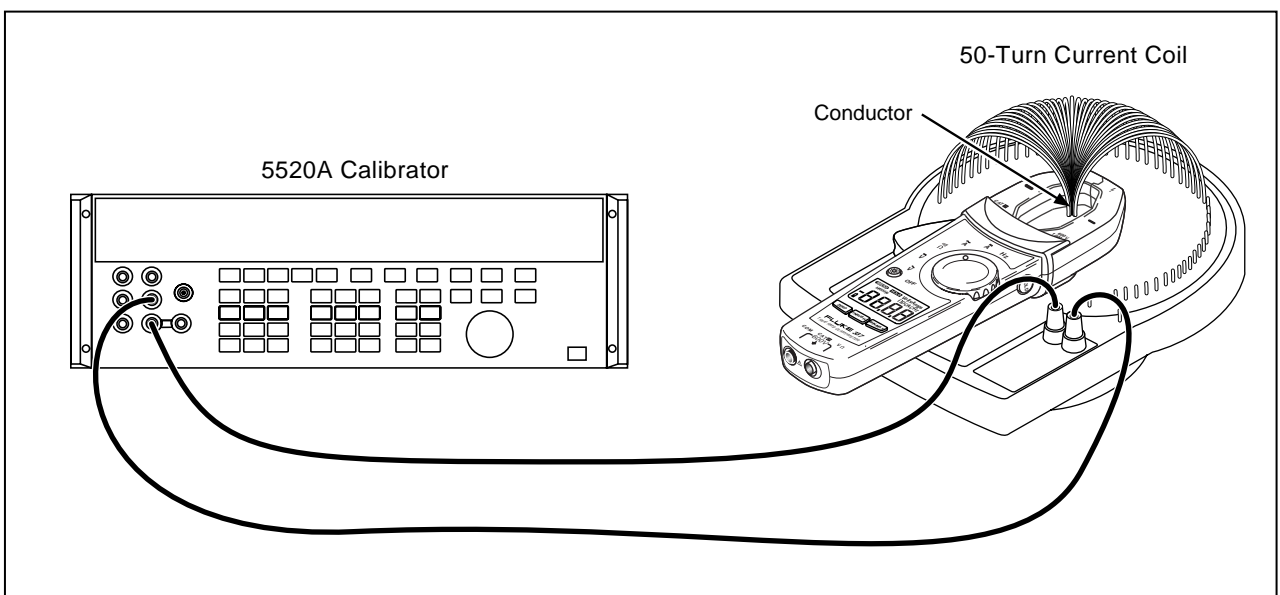

Figure 4. 33x Amps/Hz Verification Setup

adc071.eps

Table 2. Performance Tests 333, 334, 335

Test (Switch Position)	5520A Output	Meter Response	
		Lower Limit	Upper Limit
\tilde{V} AC Volts	20 V 50 Hz	19.3 V AC	20.7 V AC
	600 V 50 Hz	593.5 V AC	606.5 V AC
\bar{V} DC Volts	20 V	19.3 V DC	20.7 V DC
	-20 V	-19.3 V DC	-20.7 V DC
	600 V	593.5 V DC	606.5 V DC
	-600 V	-593.5 V DC	-606.5 V DC
\equiv) Continuity	25 Ω	Beeper On	
Ω Ohms	600 Ω	590.5 Ω	609.5 Ω
	6 K Ω (334, 335)	5905 Ω	6095 Ω
\tilde{A} Amps AC	20 A 50 Hz	19.1 A AC	20.9 A AC
	200 A 50 Hz	195.5 A AC	204.5 A AC
	400 A 50 Hz (333)	391.5	408.5
	600 A 50 Hz (334, 335)	587.5 A AC	612.5 A AC
Inrush	*5 A 60 Hz	4.4 A AC	5.6 A AC
* display should bar (- - -), then show reading with inrush light on (334, 335)			

Table 2. Performance Tests 336, 337 (cont.)

Test (Switch Position)	5520A Output	Meter Response	
		Lower Limit	Upper Limit
\tilde{V} AC Volts	20 V 50 Hz	19.3 V AC	20.7 V AC
	600 V 50 Hz	593.5 V AC	606.5 V AC
	600 V 400 Hz	563.5 V AC	636.5 V AC
Min/Max (337)	600 V 400 Hz	563.5 V AC	636.5 V AC
	20 V 400 Hz	Reading does not change	
\bar{V} DC Volts	20 V	19.3 V DC	20.7 V DC
	-20 V	-19.3 V DC	-20.7 V DC
	600 V	593.5 V DC	606.5 V DC
	600 V	-593.5 V DC	-606.5 V DC
 Continuity	25 Ω	Beeper On	
Ω Ohms	600 Ω	590.5 Ω	609.5 Ω
	6 K Ω	5905 Ω	6095 Ω
\tilde{A} Amps AC	20 A 50 Hz	19.1 A AC	20.9 A AC
	200 A 50 Hz	195.5 A AC	204.5 A AC
	200 A 400 Hz	187.5 A AC	212.5 A AC
	600 A 50 Hz	-612.5 A AC	-587.5 A AC
	900 A 50 Hz (337 only)	-918.5 A AC	-881.5 A AC
Inrush	*5 A 60 Hz	4.4 A AC	5.6 A AC
\bar{A} DC Amps	0.0 A after button push	-0.5 A DC	0.5 A DC
	20.0 A	19.1 A DC	20.9 A DC
	-20.0 A	-19.1 A DC	-20.9 A DC
	600.0 A	587.5 A DC	612.5 A DC
	-600.0 A	-587.5 A DC	-612.5 A DC
	900.0 A (337)	881.5 A DC	918.5 A DC
	-900.0 A (337)	881.5 A DC	918.5 A DC
Frequency (337)	5 A 10 Hz	9.4 Hz	10.6 Hz
	10 A 300 Hz	298.0 Hz	302.0 Hz
*display should bar (- - -), then show reading with inrush light on			

Calibration Adjustment 333, 334, & 335

Use the following steps to adjust the calibration of the 333, 334, and 335 meters (refer to Figure 5):

1. Remove the 2 screw on the bottom of the Meter.
2. Lift off the top case.
3. Apply 600.0 V 50 Hz.
4. Adjust R12 until display reads within 1.0 V.
5. Apply 200.0 A 50 Hz (remove 600 Vac).
6. Adjust R15 until the display reads within 0.5 A.
7. Replace the top case.
8. Replace the case screws.
9. Verify the calibration by going through the performance test procedures.

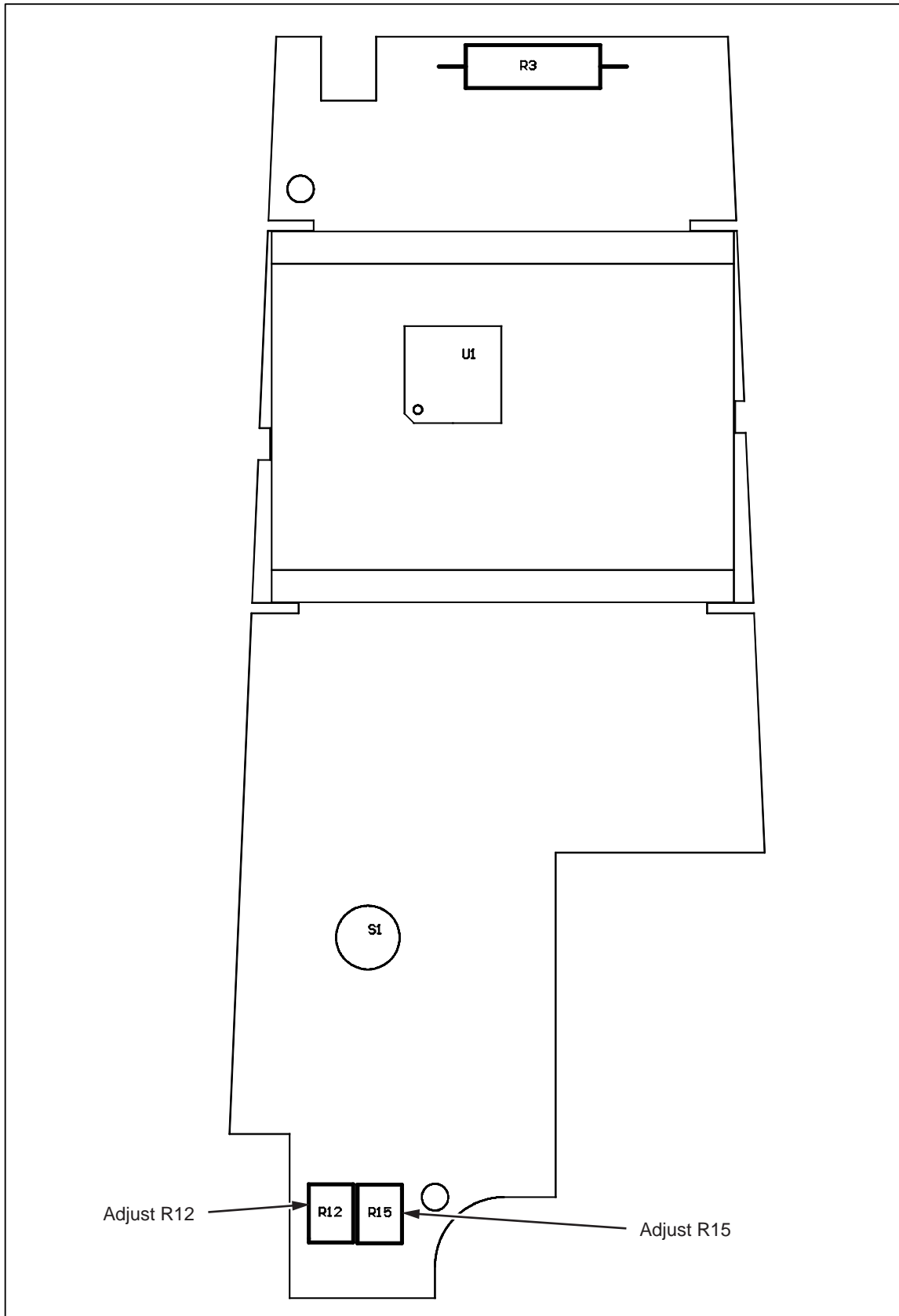

Figure 5. Calibration Adjustment Points (333-335)

adc05f.eps

Calibration Adjustment 336 & 337

Use the following steps to adjust the calibration of the 336 and 337 meters (refer to Figures 5 and 6):

1. Remove the 2 screw on the bottom of the Meter.
2. Lift off the top case.
3. Apply 600.0 V 50 Hz.
4. Adjust R12 until the UUT display reads within 1.0 V.
5. Remove 600.0 V.
6. Change to the A DC Function.
7. Adjust R60 until the display reads within 2.0 A of 0 A DC.
8. Change to the A AC function.
9. Apply 100.0 A 50 Hz.
10. Note measurement with wire at top and bottom of jaw opening.
11. Adjust R9 until this difference is within 1.0 A.
12. Replace top case.
13. Open battery door and remove the batteries.
14. Apply 2.7 V to 3.2 V to battery terminals.
15. Change to AAC function.
16. Apply 600.0 A 50 Hz.
17. Adjust R61 until the display reads within 1.0 A.
18. Replace the batteries.
19. Verify the calibration by going through the Performance Test procedures.

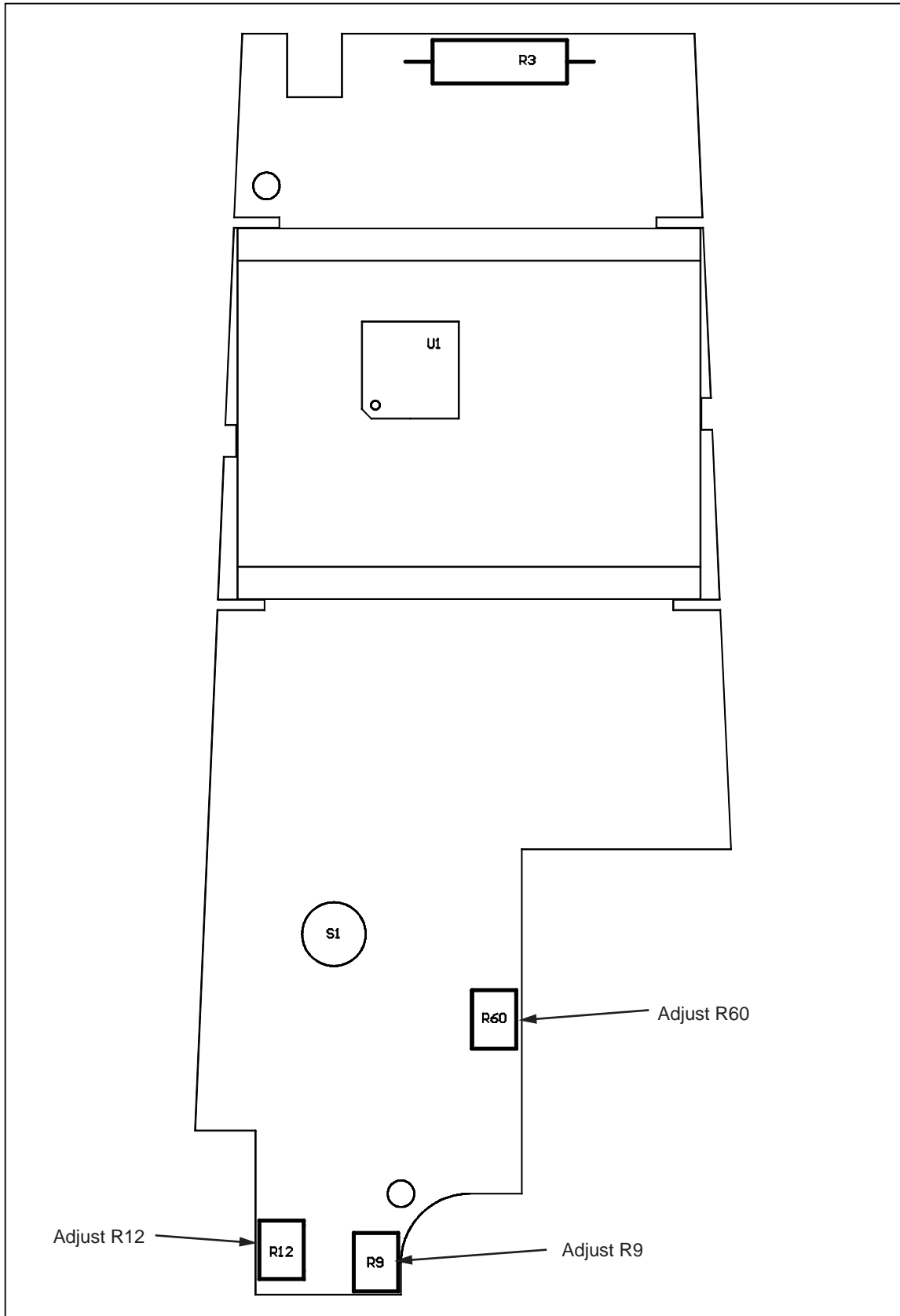
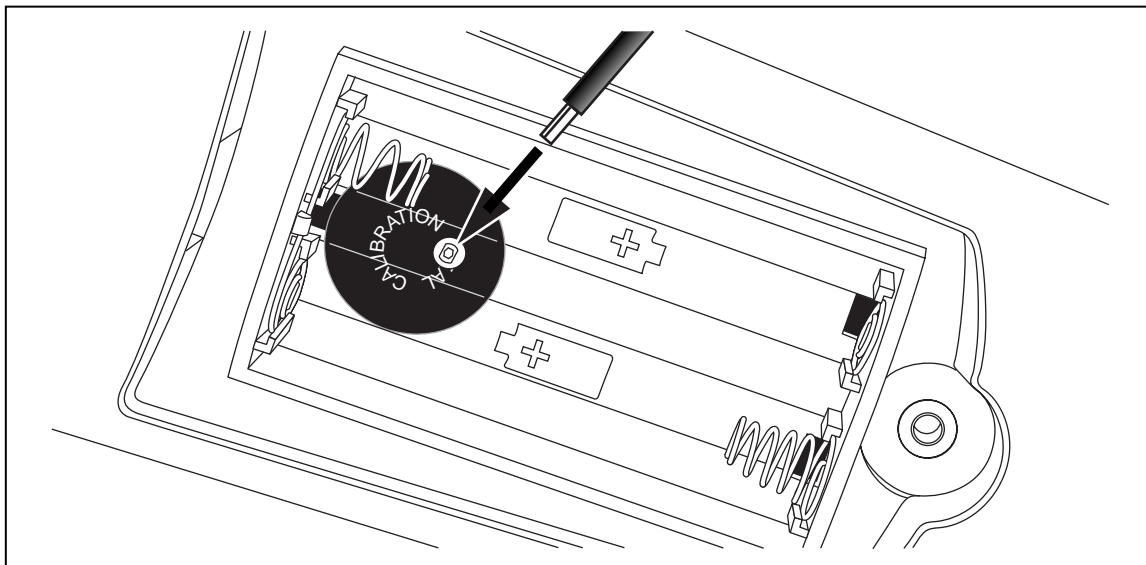

Figure 6. Calibration Adjustment Points 336-337

adc06f.eps



adc04f.eps

Figure 7. Calibration Adjustment (336-337)

User-Replaceable Parts and Accessories

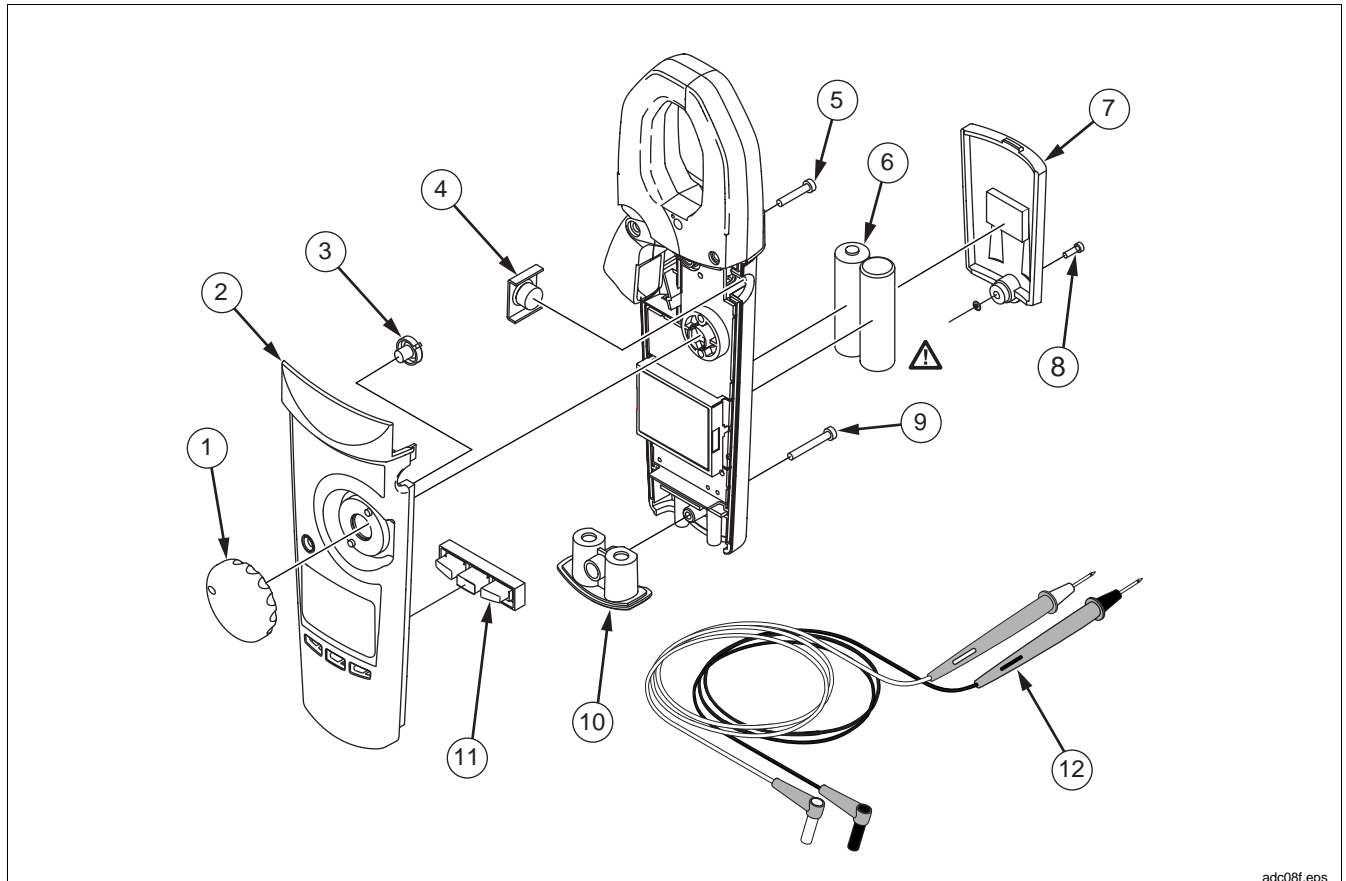

adc08f.eps

Item #	Description	Part No	Qty
①	Knob	1611630	1
②	Case Top (Model 333) Case Top (Model 334) Case Top (Model 335) Case Top (Model 336) Case Top (Model 337)	1611439 1611442 1611456 1611474 1611488	1 1 1 1 1
③	Button, Backlight (334-337)	1611585	1
④	Button, Hold	1611572	1
⑤	Screw, case (small)	1611682	1
⑥	Battery, 1.5V, 0-150MA, AA Alkaline	376756	2
⑦	Battery Door	1611653	1
⑧	Screw, Battery Door	1611694	1
⑨	Screw, case (large)	1611666	1
⑩	Input Recepticle Housing	1611648	1
⑪	Keypad (334,335) Keypad (336) Keypad (337)	1611597 1611611 1611627	1 1 1
⑫	TL75 Test Lead Set**	855705	1
Not Shown	Softcase	1587541	1
Not Shown	333, 334, 335, 336, and 337 Safety Sheet	1561546	1
Not Shown	333,334, and 335 Instruction Card 336 and 337 Instruction Card	1549865 1549876	1 1
Not Shown	Calibration Manual	1618765	1

* ⚠ To ensure safety, use exact replacement only.

** Fluke accessories are available from your authorized Fluke distributor.

Figure 8. User-Replaceable Parts and Accessories

LIMITED WARRANTY AND LIMITATION OF LIABILITY

This Fluke product is warranted to be free from defects in material and workmanship under normal use and service. The warranty period is three years and begins on the date of shipment. Parts, product repairs, and services are warranted for 90 days. This warranty extends only to the original buyer or end-user customer of a Fluke authorized reseller, and does not apply to fuses, disposable batteries, or to any product which, in Fluke's opinion, has been misused, altered, neglected, contaminated, or damaged by accident or abnormal conditions of operation or handling. Fluke warrants that software will operate substantially in accordance with its functional specifications for 90 days and that it has been properly recorded on non-defective media. Fluke does not warrant that software will be error free or operate without interruption.

Fluke authorized resellers shall extend this warranty on new and unused products to end-user customers only but have no authority to extend a greater or different warranty on behalf of Fluke. Warranty support is available only if product is purchased through a Fluke authorized sales outlet or Buyer has paid the applicable international price. Fluke reserves the right to invoice Buyer for importation costs of repair/replacement parts when product purchased in one country is submitted for repair in another country.

Fluke's warranty obligation is limited, at Fluke's option, to refund of the purchase price, free of charge repair, or replacement of a defective product which is returned to a Fluke authorized service center within the warranty period.

To obtain warranty service, contact your nearest Fluke authorized service center to obtain return authorization information, then send the product to that service center, with a description of the difficulty, postage and insurance prepaid (FOB Destination). Fluke assumes no risk for damage in transit. Following warranty repair, the product will be returned to Buyer, transportation prepaid (FOB Destination). If Fluke determines that failure was caused by neglect, misuse, contamination, alteration, accident, or abnormal condition of operation or handling, including overvoltage failures caused by use outside the product's specified rating, or normal wear and tear of mechanical components, Fluke will provide an estimate of repair costs and obtain authorization before commencing the work. Following repair, the product will be returned to the Buyer transportation prepaid and the Buyer will be billed for the repair and return transportation charges (FOB Shipping Point).

THIS WARRANTY IS BUYER'S SOLE AND EXCLUSIVE REMEDY AND IS IN LIEU OF ALL OTHER WARRANTIES, EXPRESS OR IMPLIED, INCLUDING BUT NOT LIMITED TO ANY IMPLIED WARRANTY OF MERCHANTABILITY OR FITNESS FOR A PARTICULAR PURPOSE. FLUKE SHALL NOT BE LIABLE FOR ANY SPECIAL, INDIRECT, INCIDENTAL OR CONSEQUENTIAL DAMAGES OR LOSSES, INCLUDING LOSS OF DATA, ARISING FROM ANY CAUSE OR THEORY.

Since some countries or states do not allow limitation of the term of an implied warranty, or exclusion or limitation of incidental or consequential damages, the limitations and exclusions of this warranty may not apply to every buyer. If any provision of this Warranty is held invalid or unenforceable by a court or other decision-maker of competent jurisdiction, such holding will not affect the validity or enforceability of any other provision.

Fluke Corporation
P.O. Box 9090
Everett, WA 98206-9090
U.S.A.

Fluke Europe B.V.
P.O. Box 1186
5602 BD Eindhoven
The Netherlands

11/99

To register this product, go to www.fluke-warranty.com